

# Nozzle diffusers **DYCH** and **DYKH** + Plenum box **ATTS**

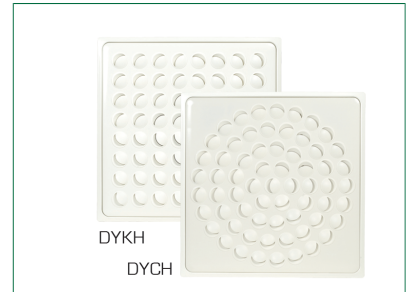
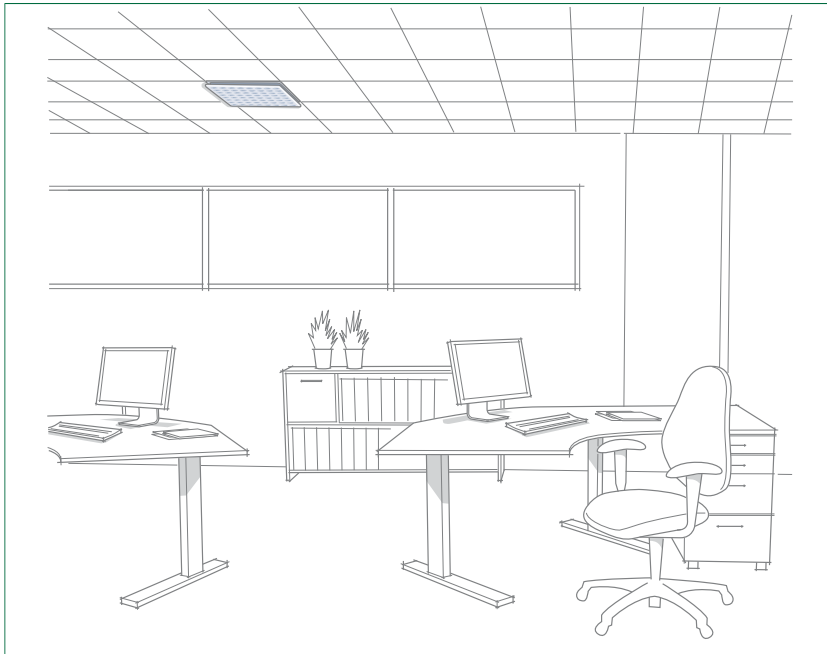

The DYCH and DYKH are quiet, ceiling-mounted nozzle diffusers. The diffusers have adjustable nozzles for the setting of an optional diffusion pattern. The diffuser DYCH has a circular nozzle pattern and the diffuser DYKH a square. The slot height of the diffusers can be set at 0 or 12 mm. Fixed to the diffuser body with magnets, the diffuser plate is easy to open. The DYCH and DYKH nozzle diffusers are also available without the plenum box.

## Quick Selection

DYCH, DYKH with 0 mm slot, 1:1 plenum box ATTS (50 Pa)

Diffuser DY(C,K)H-	Connection ATTS		Air flow l/s at sound level		
	inlet mm	outlet mm	25 dB(A)	30 dB(A)	35 dB(A)
125-4	125	125	28	34	39
125-6	125	125	29	35	40
160-4	160	160	37	43	50
160-6	160	160	45	54	65
200-4	200	200	40	52	61
200-6	200	200	61	72	82
250-6	250	250	75	94	108
315-6	315	315	88	108	129

DYCH, DYKH with 0 mm slot, 1:2 plenum box ATTS (50 Pa)

Diffuser DY(C,K)H-	Connection ATTS		Air flow l/s at sound level		
	inlet mm	outlet mm	25 dB(A)	30 dB(A)	35 dB(A)
125-4	100	125	26	32	-
125-6	100	125	25	32	-
160-4	125	160	33	43	51
160-6	125	160	36	51	60
200-4	160	200	43	57	63
200-6	160	200	45	64	78
250-6	200	250	72	87	103
315-6	250	315	92	108	128
400-6	315	400	84	124	142

- = outside working area, 4 = 425x425, 6 = 595x595

## Specifications

- Easy to install and adjust
- Low sound level
- Adjustable air slot 0 or 12 mm
- Easily adjustable diffusion pattern
- 6 connection sizes and 2 diffuser sizes (425x425 or 595x595)
- All connection sizes are suitable for suspended ceiling systems (595x595), false ceiling plate available for size 425x425
- Available with CleanVent coating
- Extremely compact plenum box ATTS
- Also available with the plenum box ATTD

## Product code example

Nozzle diffuser DYCH-250-6

Plenum box ATTS-200-250-1

### Air flow, throw, pressure drop, sound level

DYCH, DYKH + ATTS with 0 mm slot, 4-way diffusion

**Throw (isothermal)**

Sizes in the diagram below refer to air diffuser connection **DY(C,K)H-125-4 + ATTS-100-125-1 - with 0 mm slot** in mm.

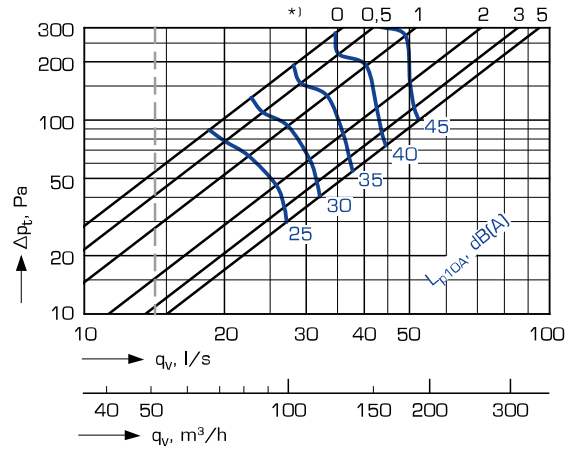
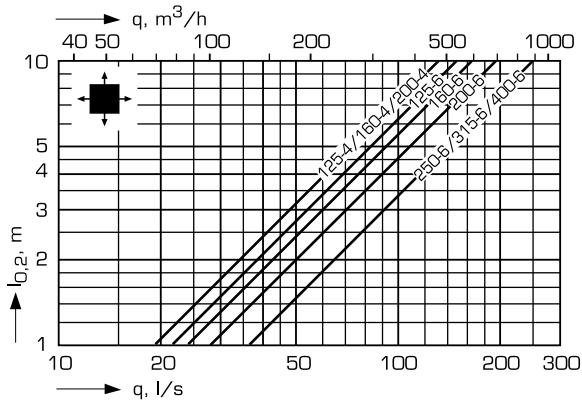

**DY(C,K)H-125-4 + ATTS-125-125-1 - with 0 mm slot**

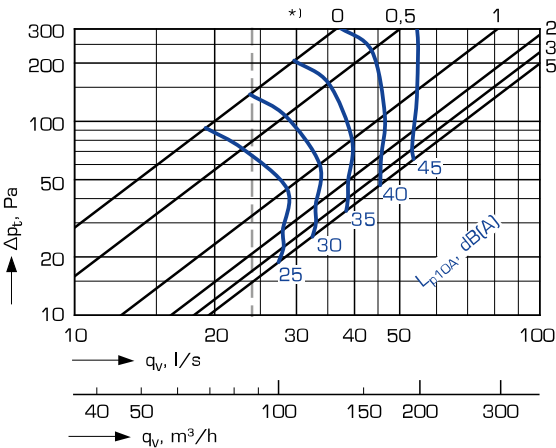

**DY(C,K)H-125-6 + ATTS-100-125-1 - with 0 mm slot**

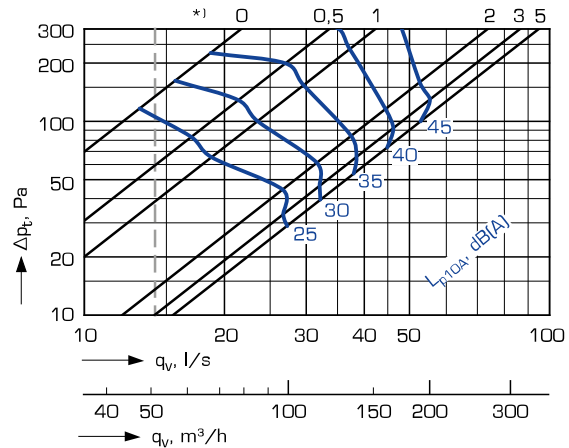

**DY(C,K)H-125-6 + ATTS-125-125-1 - with 0 mm slot**

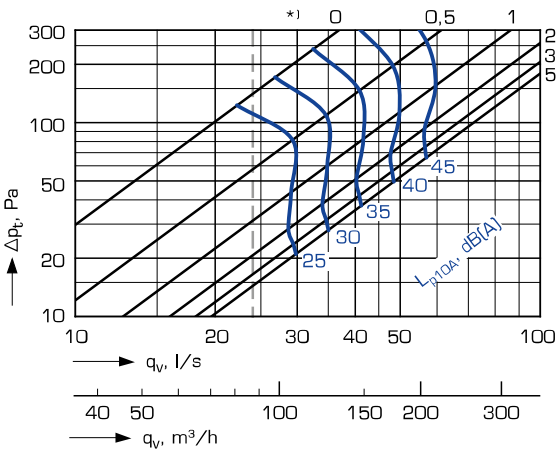

**DY(C,K)H-160-4 + ATTS-125-160-1 - with 0 mm slot**

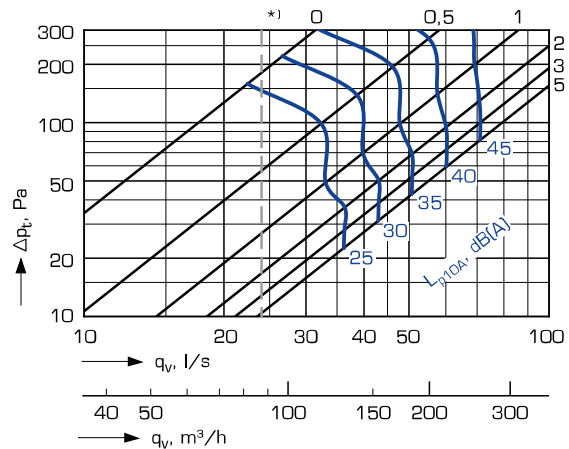

\*) adjustment position

---- Min. airflow required to obtain sufficient measuring pressure.

### Air flow, pressure drop, sound level

DYCH, DYKH + ATTS with 0 mm slot, 4-way diffusion

DY(C,K)H-160-4 + ATTS-160-160-1 - with 0 mm slot

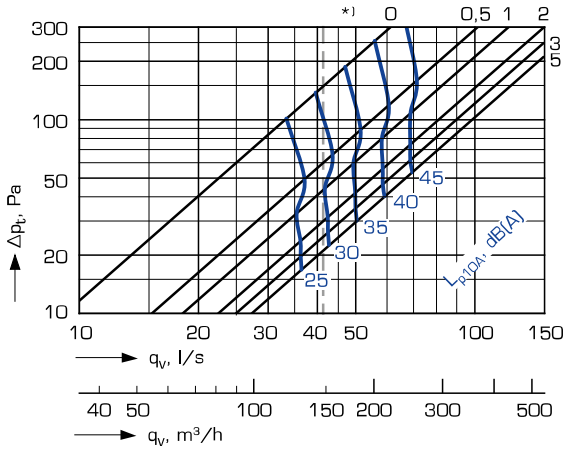

DY(C,K)H-160-6 + ATTS-125-160-1 - with 0 mm slot

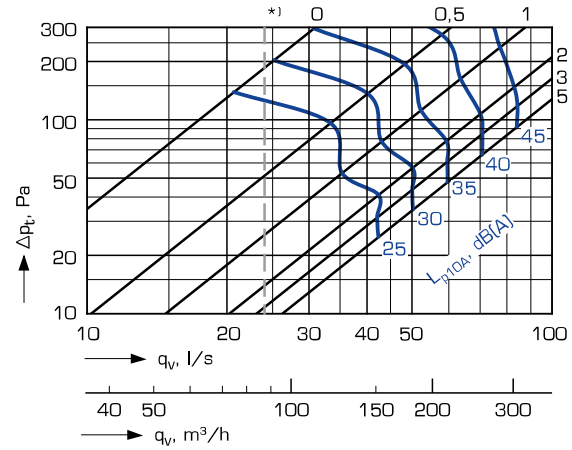

DY(C,K)H-160-6 + ATTS-160-160-1 - with 0 mm slot

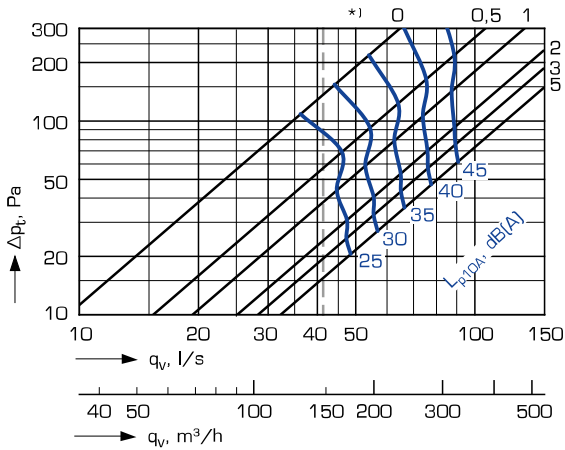

DY(C,K)H-200-4 + ATTS-160-200-1 - with 0 mm slot

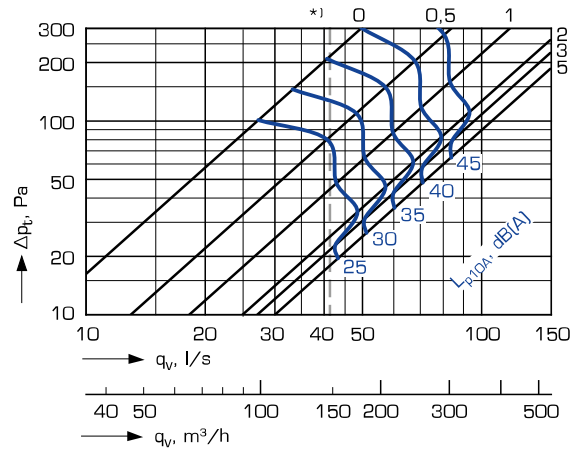

DY(C,K)H-200-4 + ATTS-200-200-1 - with 0 mm slot

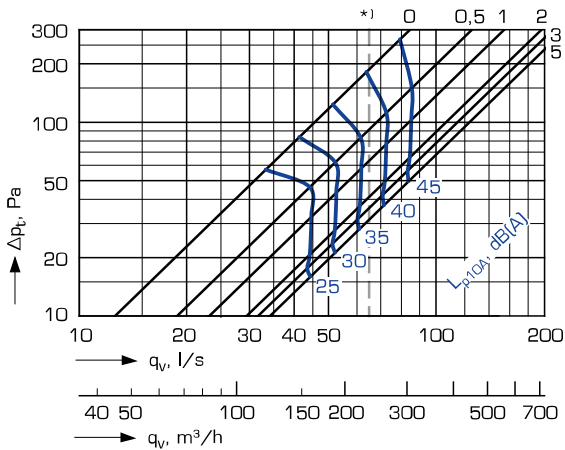

DY(C,K)H-200-6 + ATTS-160-200-1 - with 0 mm slot

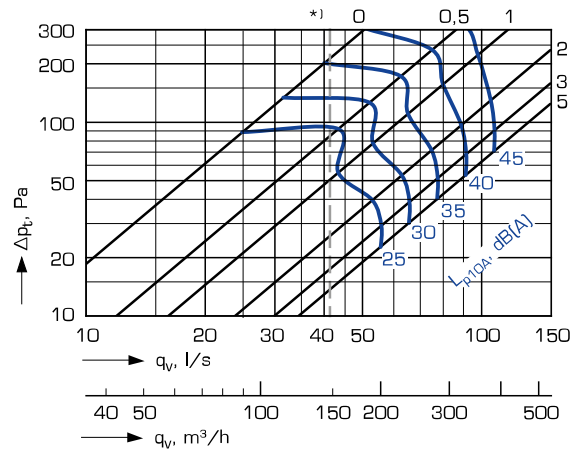

\*) adjustment position

---- Min. airflow required to obtain sufficient measuring pressure.

### Air flow, pressure drop, sound level

DYCH, DYKH + ATTS with 0 mm slot, 4-way diffusion

DY(C,K)H-200-6 + ATTS-200-200-1 - with 0 mm slot

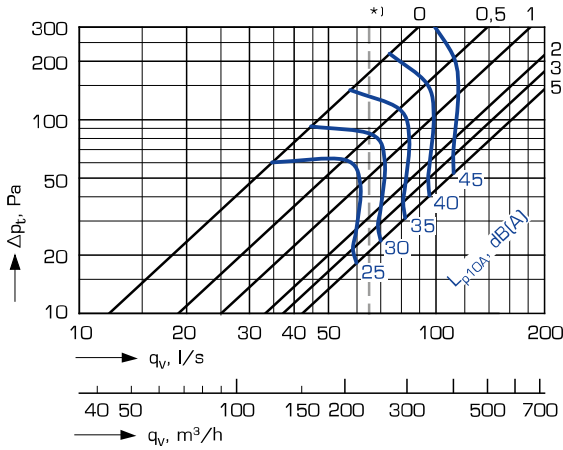

DY(C,K)H-250-6 + ATTS-200-250-1 - with 0 mm slot

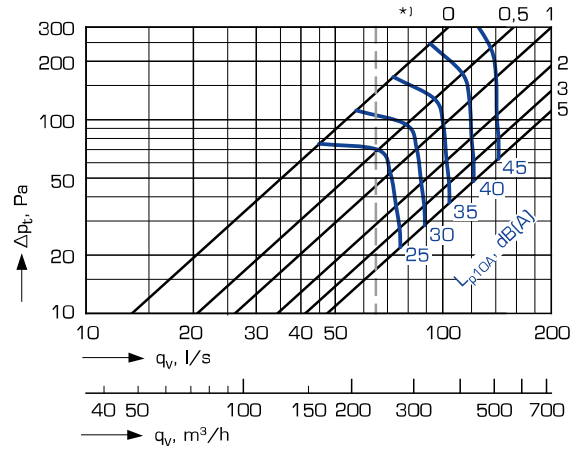

DY(C,K)H-250-6 + ATTS-250-250-1 - with 0 mm slot

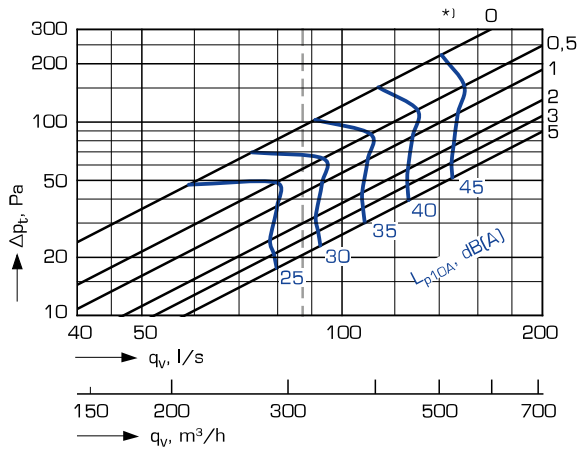

DY(C,K)H-315-6 + ATTS-250-315-1 - with 0 mm slot

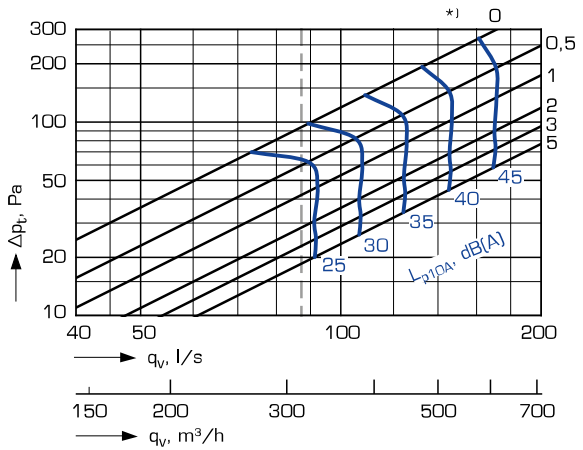

DY(C,K)H-315-6 + ATTS-315-315-1 - with 0 mm slot

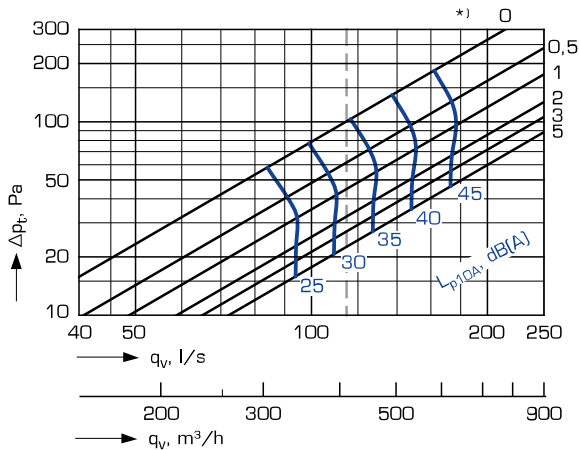

DY(C,K)H-400-6 + ATTS-315-400-1 - with 0 mm slot

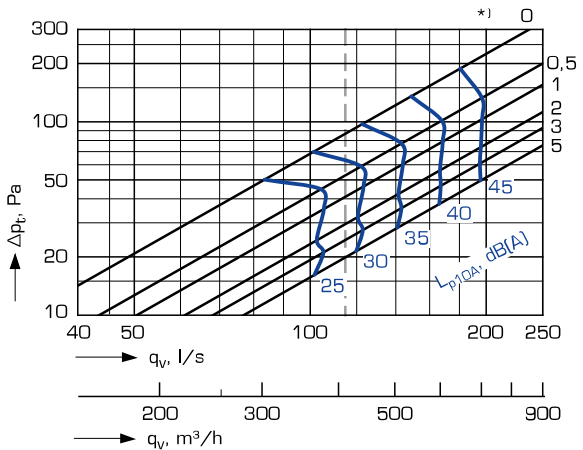

\*) adjustment position

---- Min. airflow required to obtain sufficient measuring pressure.

### Air flow, pressure drop, sound level

Nozzle diffuser DYCH, DYKH with 0 mm slot, 4-way diffusion

Nozzle diffuser DYCH, DYKH with 0 mm slot  
4-way diffusion

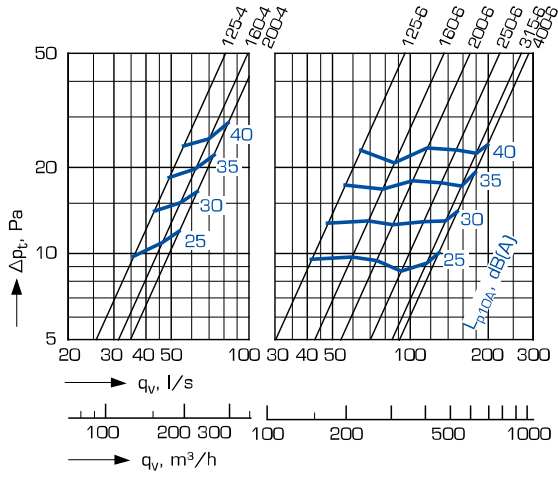

## Sound power level L<sub>w</sub>

### DY(C,K)H + ATTS with 0 mm slot, 1:1 plenum box

Diffuser DY(C,K)H-	Connection ATTS		Correction of sound level K (dB)							
	inlet mm	outlet mm	63	125	250	500	1000	2000	4000	8000
125-4	125	125	9	11	3	2	0	-10	-16	-15
125-6	125	125	11	12	6	2	-2	-11	-17	-15
160-4	160	160	6	5	0	3	1	-11	-20	-20
160-6	160	160	8	8	3	3	0	-9	-18	-19
200-4	200	200	3	5	-1	2	1	-10	-20	-20
200-6	200	200	5	9	2	3	0	-9	-18	-19
250-6	250	250	4	6	1	3	1	-10	-18	-19
315-6	315	315	5	5	0	2	1	-10	-21	-21
Tolerance ±			6	3	2	2	2	2	2	3

### DY(C,K)H + ATTS with 0 mm slot, 1:2 plenum box

Diffuser DY(C,K)H-	Connection ATTS		Correction of sound level K (dB)							
	inlet mm	outlet mm	63	125	250	500	1000	2000	4000	8000
125-4	100	125	10	8	6	3	-2	-11	-13	-14
125-6	100	125	10	10	7	1	-3	-9	-10	-10
160-4	125	160	6	6	5	2	0	-10	-17	-18
160-6	125	160	5	8	6	2	-1	-8	-14	-17
200-4	160	200	4	5	2	2	1	-9	-18	-19
200-6	160	200	9	7	6	2	-1	-8	-16	-18
250-6	200	250	6	7	4	2	0	-9	-17	-18
315-6	250	315	5	6	2	2	1	-10	-19	-20
400-6	315	400	3	4	1	2	2	-11	-20	-21
Tolerance ±			6	3	2	2	2	2	2	3

### Nozzle diffuser DY(C,K)H with 0 mm slot

DY(C,K)H-	Correction of sound level K (dB)							
	63	125	250	500	1000	2000	4000	8000
125-4	8	1	0	3	0	-9	-12	-8
125-6	4	-1	0	2	0	-7	-10	-6
160-4	2	3	1	2	0	-9	-12	-7
160-6	0	-5	1	2	0	-8	-13	-8
200-4	4	8	1	1	0	-9	-11	-7
200-6	8	3	1	1	0	-8	-11	-7
250-6	4	4	3	2	0	-9	-14	-8
315-6	0	3	3	2	0	-10	-13	-7
400-6	5	-5	3	2	0	-10	-12	-7
Tolerance ±		6	3	2	2	2	2	3

Sound power levels by octave bands are obtained by adding to total sound pressure level  $L_{p10A}$ , dB(A), the correction  $K_{oct}$  presented in the table according to the following formula:

$$L_w = L_{p10A} + K_{oct}$$

Correction  $K_{oct}$  is average value in range of use of the device.

## Sound attenuation $\Delta L$

### DY(C,K)H + ATTS with 0 mm slot, 1:1 plenum box

Diffuser DY(C,K)H-	Connection ATTS		Sound attenuation (dB)							
	inlet mm	outlet mm	63	125	250	500	1000	2000	4000	8000
125-4	125	125	24	14	11	19	18	18	18	17
125-6	125	125	24	10	11	18	16	16	15	17
160-4	160	160	21	10	12	15	14	14	15	17
160-6	160	160	21	11	11	12	12	13	16	17
200-4	200	200	18	8	11	15	11	10	15	17
200-6	200	200	19	8	11	15	10	11	18	18
250-6	250	250	13	6	8	12	13	12	14	14
315-6	315	315	11	5	8	8	9	11	12	15
Tolerance $\pm$			6	3	2	2	2	2	2	3

### DY(C,K)H + ATTS with 0 mm slot, 1:2 plenum box

Diffuser DY(C,K)H-	Connection ATTS		Sound attenuation (dB)							
	inlet mm	outlet mm	63	125	250	500	1000	2000	4000	8000
125-4	100	125	23	14	11	13	17	16	18	15
125-6	100	125	23	14	12	14	15	12	16	15
160-4	125	160	23	12	9	14	19	16	13	15
160-6	125	160	22	13	8	16	17	15	14	16
200-4	160	200	24	11	8	14	14	10	14	14
200-6	160	200	23	11	8	15	12	10	17	14
250-6	200	250	18	7	8	13	10	10	13	14
315-6	250	315	12	7	5	11	11	10	12	13
400-6	315	400	12	5	6	7	9	10	10	14
Tolerance $\pm$			6	3	2	2	2	2	2	3

### Nozzle diffuser DY(C,K)H with 0 mm slot

DY(C,K)H-	Sound attenuation (dB)								
	63	125	250	500	1000	2000	4000	8000	
125-4	18	14	6	2	4	5	4	5	
125-6	20	13	5	3	1	2	3	3	
160-4	18	11	5	1	3	2	5	5	
160-6	17	11	4	3	1	0	3	3	
200-4	16	11	4	1	3	4	5	5	
200-6	15	10	4	2	1	2	3	4	
250-6	13	7	2	0	0	2	2	3	
315-6	12	7	2	0	1	2	3	4	
400-6	10	6	1	-1	1	2	3	5	
Tolerance $\pm$									
	6	3	2	2	2	2	2	3	

The average sound attenuation  $\Delta L$  from duct to room including the orifice attenuation of the connecting duct in ceiling installation, is obtained in the table above.

More technical data can be found in our selection tool. Contact our nearest sales office for further information.

## Dimensions and weights

### Nozzle diffuser DYKH, DYCH

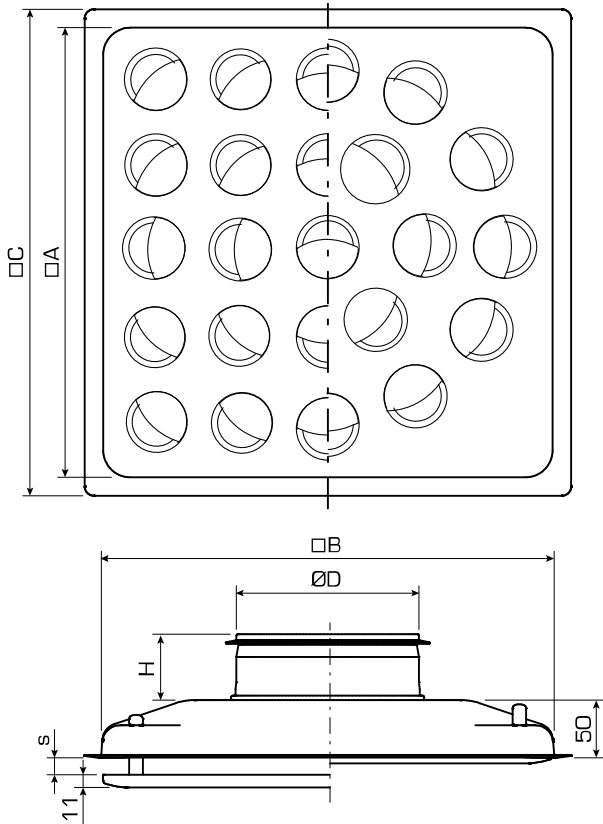

s = 0 or 12 mm

Size	A [mm]	B [mm]	C [mm]	ØD [mm]	H [mm]	Opening [mm]	Weight [kg]
125-4	395	399	425	124.3	58	410	2.2
125-6	565	569	595	124.3	58	580	4.1
160-4	395	399	425	159.3	58	410	2.2
160-6	565	569	595	159.3	58	580	4.1
200-4	395	399	425	199.3	58	410	2.1
200-6	565	569	595	199.3	58	580	4.1
250-6	565	569	595	249.3	58	580	4.0
315-6	565	569	595	314.3	58	580	3.9
400-6	565	569	595	393.3	66	580	3.9

### Plenum box ATTS

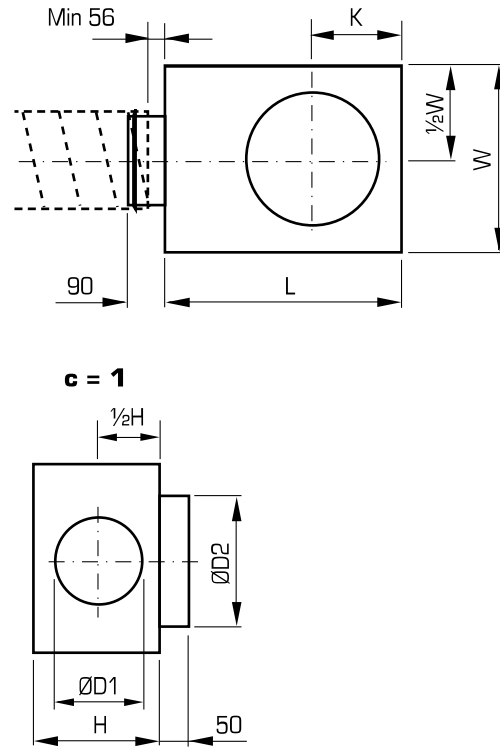

Size	ØD1 [mm]	ØD2 [mm]	H [mm]	L [mm]	W [mm]	K [mm]	Weight [kg]
100-125	99.3	125	170	300	220	115	1.6
125-125	124.3	125	170	340	300	133	2.1
125-160	124.3	160	170	340	300	133	2.1
160-160	159.3	160	195	380	340	153	2.7
160-200	159.3	200	195	380	340	153	2.6
200-200	199.3	200	235	480	380	178	3.7
200-250	199.3	250	235	480	380	178	3.6
250-250	249.3	250	285	530	380	211	4.3
250-315	249.3	315	285	530	380	211	4.2
315-315	314.3	315	335	530	480	253	5.5
315-400	314.3	400	335	530	480	253	5.4

### DYCH, DYKH + ATTS



DY(C,K)H	Gmin [mm]		Gmax [mm]	
	1:1 ATTS	1:2 ATTS	1:1 ATTS	1:2 ATTS
125-4	270	270	300	300
125-6	270	270	300	300
160-4	295	270	325	300
160-6	295	270	325	300
200-4	335	295	365	325
200-6	335	295	365	325
250-6	385	335	415	365
315-6	435	385	465	415
400-6	-	435	-	465



## Execution and function

The DYCH and DYKH are ceiling-mounted nozzle diffusers. The design of the nozzles provides a highly effective mixing of the supply air with the air in the premises (high induction rate). The nozzles are rotatable and offer the possibility of changing the diffusion pattern and the diffusion direction for adaptation to the actual needs. Optimal air distribution is assured in this way, even in the case of cooling. The slot height of the diffuser can be set at 0 or 12 mm. Both diffusers are square in shape, the nozzle pattern being circular in the DYCH and square in the DYKH. Fixed to the diffuser body with magnets, the diffuser plate is easy to open. This supply air unit is suitable for both suspended ceiling systems and false ceilings built on site.

The ATTS plenum box features an extremely quiet patented measurement and adjustment damper for multipoint measuring with balanced and accurate values. The adjustment handle of the measurement and adjustment damper has a position indicator and a locking device. The measurement and adjustment damper can be easily removed for inspection and cleaning without changing the setting. The diffuser connection collar is outwards in the plenum box. The ATTS plenum box is applicable for supply and exhaust air alike. In exhaust air use, the position of the measuring hose is changed to the measuring connector inside the box.

## General

### Material and surface finish

Both the diffuser and the plenum box are made from steel sheet.

The diffuser is powder-coated for a high surface finish.

The standard colour is RAL 9010. Other diffuser colours and CleanVent coating (for metal parts only) are available on special order.

The nozzles are made of white plastic and have antistatic treatment.

### Installation, adjustment and maintenance

The instructions for installation, adjustment and maintenance are available at [www.flaktgroup.com](http://www.flaktgroup.com). The k-factors for supply air are also provided on the plenum box.

### Technical data and design

For complete design details, please see the FläktGroup product selection program. The program can be found on the Internet at [www.flaktgroup.com](http://www.flaktgroup.com).

### Product description

The square nozzle diffuser, DYCH/DYKH by FläktGroup with a plenum box, ATTS. The DYCH/DYKH diffuser has adjustable nozzles and can be set to provide an air slot of 0 or 12 mm. The diffuser plate, fixed to the diffuser body with magnets, is easy to open. The ATTS plenum box includes a quiet, easily removable measurement and adjustment damper (ZAEF).

## Product code

Nozzle diffuser	DY(C,K)H-aaa-b
Nozzle diffuser, CleanVent	DY(C,K)H-aaa-b-C
Nozzle diffuser, special colour	DY(C,K)H-aaa-b-E

### Execution

C = with circular nozzle pattern

K = with square nozzle pattern

### Size (aaa)

125, 160, 200, 250, 315, 400 (diffuser connection)

### Body size (b)

4 = 425 x 425

6 = 595 x 595

### CleanVent coated (C)

### Special colour (E)

Plenum box	ATTS-aaa-bbb-c
------------	----------------

### Duct connection in mm (aaa)

### Diffuser connection in mm (bbb)

### Type (c)

1 = collar outwards

## Accessories

False ceiling plate	UTKZ-395
for sizes 125-4, 160-4 and 200-4 (body size of diffuser 425 x 425)	

Diffuser plate with circular nozzle pattern (from 9/2017)	DYCZ-a-B
Diffuser plate with square nozzle pattern (from 9/2017)	DYKZ-a-B

Body size of diffuser (a)

4 = 425 x 425

6 = 595 x 595

Includes painted diffuser plate with plastic nozzles.

AIRTREND Ltd.  
 Predstavništvo u Beogradu  
 Kumanovska 14  
 11000 Beograd  
 Tel: 011 3836886, 3085740  
 Faks: 011 3444113  
 e-mail: gobrid@eunet.rs  
 web: www.airtrend.rs